

V1.0

TV CONTROL BOARD SPECIFICATION

MODEL: T.VST59S.81A

(Asia-mini3)

Part Number: MST-12061978

AUTHOR:  2012.06.2
音小丽 0 15:10:38
+08'00'

CHECKED BY:  2012.06.28
家林通 15:10:40 +08'00'

RECHECKED BY:

APPROVED BY:

PUBLISHED DATE: 2012-06-20

CONTENT

ITEM	PAGE
1.GENERAL DESCRIPTION	2
2.FUNCTION LAYOUT	2
3.FEATURES	4
4.PCB DIMENSIONS	8
5.SCHEMATICS OF IR & KEY BOARD	9
6.INTERFACE DEFINITION	9
7.CONFIGURATION & GENERAL PRECAUTIONS	12
APPENDIX: ANOTHER TWO STRUCTURE	13

REVISION HISTORY

VERSION	DATE	BOARD ID	PAGE	DESCRIPTION	AUTHOR
V1.0	2012.06.19	T.VST59S.81A 12236	All	First issued.	Linda

1. GENERAL DESCRIPTION

T.VST59S.81A is analog TV control board, which is suitable for Asia-Pacific and Middle-East market. It can support more than 26 inch LED panels which resolution is up to 1920×1080.

USB2.0 support multimedia playback and Software upgrade.

The HDMI support 1.4, the HDCP support1.1.

2. FUNCTION LAYOUT

Note:

Pictures are for reference only, specific to prevail in kind.

The optional connectors and terminals are marked with “*”.

FRONT VIEW OF T.VST59S.81A (81_A3)

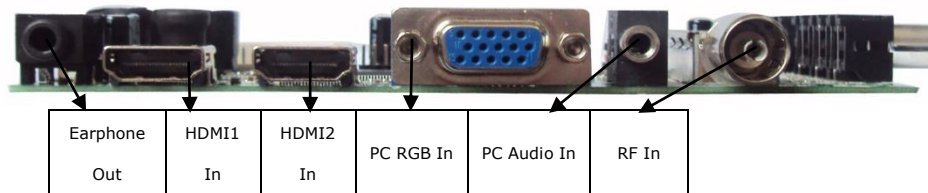

SIDE VIEW OF T.VST59S.81A (81_A3)

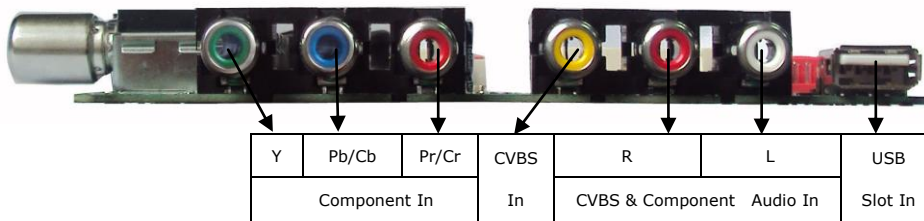

TOP VIEW OF T.VST59S.81A (81_A3)

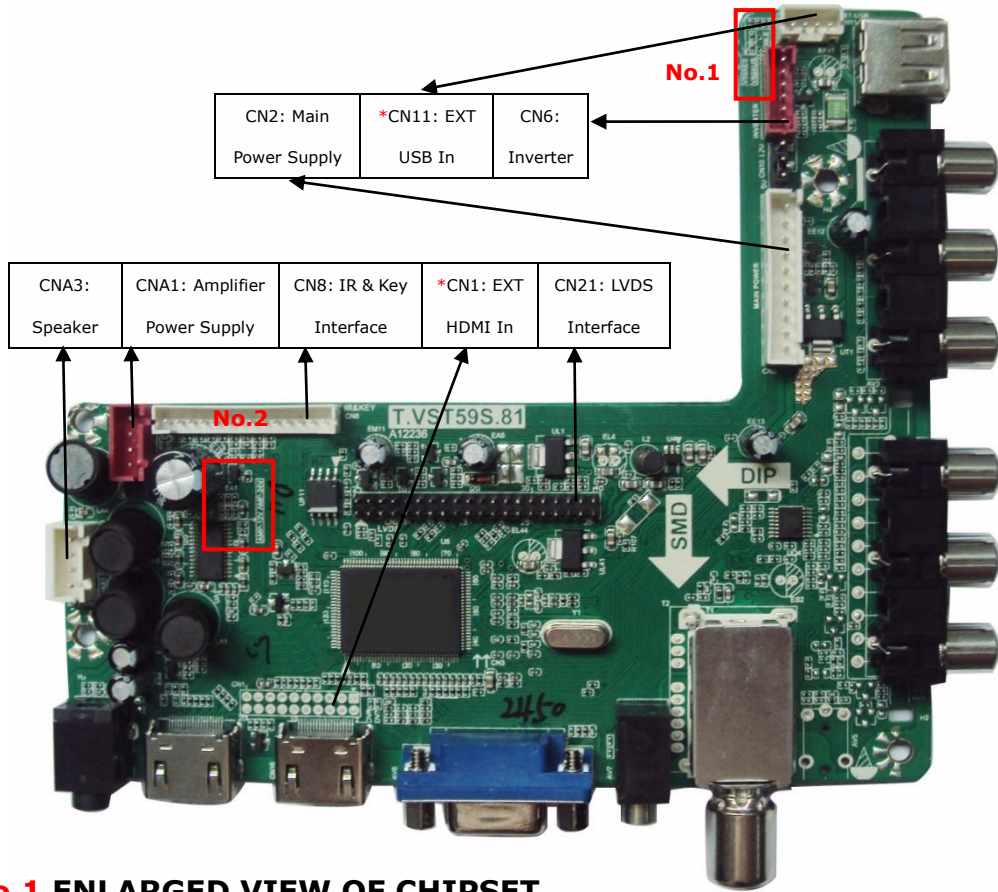

No.1 ENLARGED VIEW OF CHIPSET

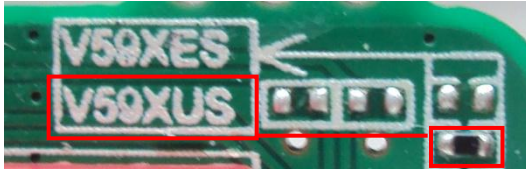

As the picture shows in left, difference the board and chipset by resistance and mark.

No.2 ENLARGED VIEW OF AMLIFIER

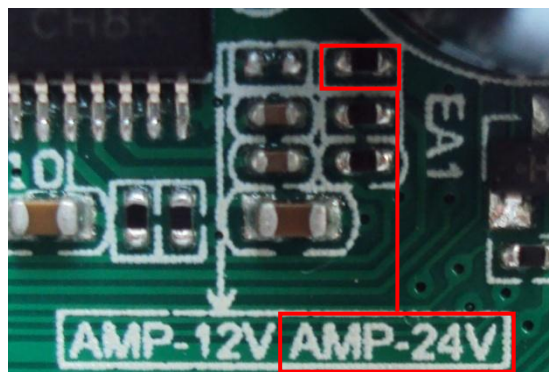

As the picture shows in left, difference the board and power of amplifier by resistance and mark.

3. FEATURES

CHIPSET	TSUMV59X US -Z1(without TELETEXT and NICAM)			
	TSUMV59X ES -Z1 (with TELETEXT and NICAM)			
MARKET AREA	Asia-Pacific, Middle-East			
OSD LANGUAGE	Chinese, English			
PANEL	Panel Type	LED		
	Interface	Dual/Single LVDS Interface		
	Max Resolution	1920×1080		
VIDEO INPUT	TV	Receiving Range	48.25MHz ~ 863.25MHz	
		Input impedance	75Ω	
		Video System	PAL, SECAM	
		Sound System	BG, DK, I	
			NICAM/A2 (Only for TSUMV59X ES -Z1)	
		TELETEXT (Only for TSUMV59X ES -Z1)	1000Pages	
	Max Storage Channels	199CH		
	PC-RGB	Format	Up to 1920×1080@60Hz	
	CVBS	Video System	PAL/NTSC/SECAM	
		Video level	1.0 V _{p-p} ±5%	
	Component	480i, 480p, 576i, 576p, 720p, 1080i, 1080p		
HDMI	480i, 480p, 576i, 576p, 720p, 1080i, 1080p			
AUDIO INPUT	PC Audio	Earphone Input	0.2 ~ 2.0 V _{RMS}	
	CVBS Audio	L/R RCA Input	0.2 ~ 2.0 V _{RMS}	
	Component Audio			
VIDEO OUTPUT	CVBS	Video System	PAL/NTSC/SECAM	
		Video level	1.0 V _{p-p} ±5%	
AUDIO OUTPUT	CVBS Audio	L/R RCA Input	0.2 ~ 2.0 V _{RMS}	
	Frequency Response	100Hz~15KHz @±3dB (500mV reference signal)		
	Max Output power	Amplifier power: 24V	2×9W(8Ω)	TPA3110D2PWER
		Amplifier power: 12V	2×8W(8Ω)	TPA3110LD2PWR
THD+N<10%@1KHz (Audio Input: 0.5V _{RMS})				
POWER	Requirement	For amplifier	12V or 24V (CNA1, optional)	
		Main board	12V/5V/5VSB	
	To Panel	5V, 12V		
	Management	Standby Power Consumption < 0.5W(Board Only)		
COMB FILTER	3D			
DEINTERLACE	3D			

T.VST59S.81A (Asia-mini3)-SPECIFICATION

KEY FUNCTION	INPUT, CH+, CH-, VOL+, VOL-,MENU, POWER Details can be found in part 5.
EXPANDABLE FUNCTION	External USB In, External HDMI In
Note: 1.Licenses involved in specifications above are supposed to be obtained by customers themselves. 2. The power supply for amplifier is default 24V and optional, 12V or 24V. As amplifier power is different, circuits are different. The amplifier power should be identified with the actual item.	

USB DEVICE PARAMETERS

	Maximum USB size	Maximum single file size
NTFS	2T	2T
FAT 32	192G	4G
FAT 16	2G	2G

SUBSTITUTABLE PRIMARY MATERIALS

The table is for reference only, the actual item is the standard.

NAME	TYPE	BRAND	BACKUP TYPE	BACKUP BRAND
TUNER	R620D	Rafael	--	--
FLASH	GD25Q32SIP (32M bits)	GIGA	W25Q32FVSSIG	Winbond
AMPLIFIER	TPA3110LD2PWR(12V) or TPA3110D2PWER(24V)	TI	--	--

1.The power supply for amplifier is default 24V and is optional, 12V or 24V.
2.TPA3110D2PWER can work with +24V or +12V power supply, TPA3110LD2PWR work with +12V supply only.

ELECTRICAL CHARACTERISTICS & REQUIREMENTS

Note:

- ◆ The power supply for amplifier is default 24V and is optional, 12V or 24V.
- ◆ TPA3110D2POWER can work with +24V or +12V power supply, TPA3110LD2PWR work with +12V supply only.

For 12V Amplifier Power

Power Supply Mode	Symbol	Voltage Range	Max Current	Ripple Voltage @25°C	Startup Time	Rise Time
12V/5V/5VSB (Built-In)	12V	12V±10%	2000mA	120mV _{p-p}	≤100ms	≤50ms
	5V	5V~5.25V	1500mA	50mV _{p-p}	≤100ms	≤50ms
	5VSB	5V~5.25V	500mA	50mV _{p-p}	--	≤50ms

Note: The current of panel, inverter and extension modules are not included in max current.

For 24V Amplifier Power

Power Supply Mode	Symbol	Voltage Range	Max Current	Ripple Voltage @25°C	Startup Time	Rise Time
24V/12V/5V/5VSB (Built-In)	24V	22V~25V	1000mA	240mV_{p-p}	≤100ms	≤50ms
	12V	12V±10%	300mA	120mV _{p-p}	≤100ms	≤50ms
	5V	5V~5.25V	1500mA	50mV _{p-p}	≤100ms	≤50ms
	5VSB	5V~5.25V	500mA	50mV _{p-p}	--	≤50ms

Note: The current of panel, inverter and extension modules are not included in max current.

POWER UP TIMING

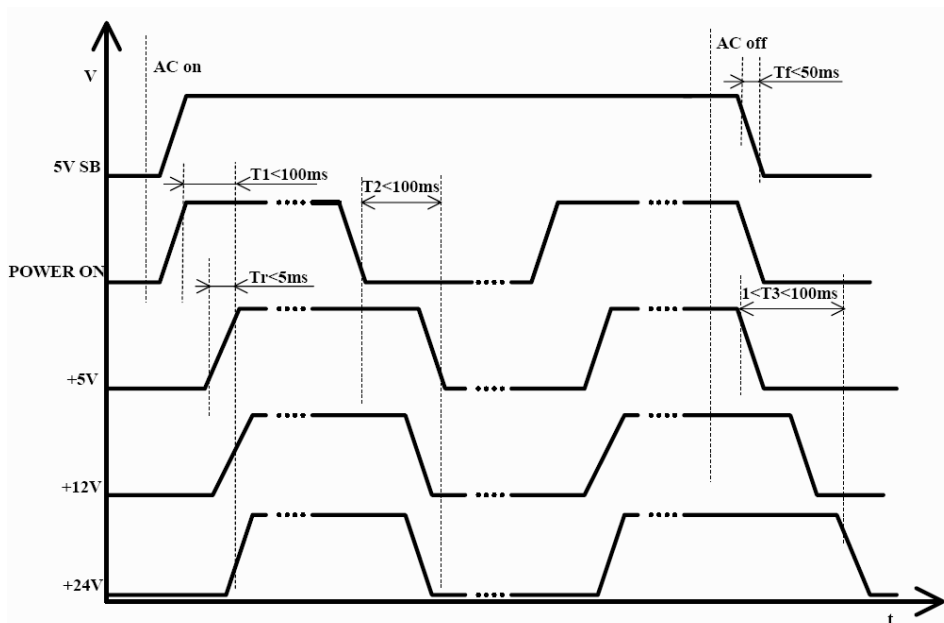

USB MULTIMEDIA PLAYBACK FORMAT

Media	File Ext.	Codec		Remark	
		Video	Audio		
Movie	.avi	MJPEG	MP3, WMA, AAC, MP2, PCM, AC3	Max Resolution And Frame Rate: 640×480@30fps Max Data Rate: 10 Mbps	
		Xvid, MPEG-2, MPEG-4, DivX, H.264		Max Resolution And Frame Rate: 1920×1080@30fps Max Data Rate: 20 Mbps	
	.mp4	MPEG-2, MPEG-4, DivX, H.264			
	.ts/ .trp	MPEG-2, H.264			
	.mkv/ .mov	MPEG-4, H.264			
	.mpg	MPEG-1, MPEG-2			
	.dat	MPEG-1		MP2	Max Resolution: 352×288 Max Data Rate: 20 Mbps
	.vob	MPEG-2			Max Resolution: 720×576 Max Data Rate: 20 Mbps
.rm/ .rmvb	RV8, RV9, RV10	COOK	Max Resolution And Frame Rate: 1280×720@30fps Max Data Rate: 10 Mbps		
Music	.mp3	--	MP3	Sample Rate: 32K~48KHz Bit Rate: 32K~320Kbps Channel: Mono/Stereo	
	.wma	--	WMA	Sample Rate: 8K~48KHz Bit Rate: 128K~320Kbps Channel: Mono/Stereo	
	.m4a/ .aac	--	AAC	Sample Rate: 8K~48KHz Bit Rate: 128K~442Kbps Channel: Mono/Stereo	
Photo	.jpg/ .jpeg	Progressive JPEG		Max Resolution: 1024×768	
		Baseline JPEG		Max Resolution: 15360×8640	
	.bmp	--		Max Resolution: 9600×6400	
	.png	Non-Interlaced		Max Resolution: 9600×6400	
Interlaced		Max Resolution: 1200×800			
Text	.txt	ANSI/UNICODE GB/UTF8		File Size: Max 1MB	
<p>File system: Hi Speed FS, FAT32, FAT16, NTFS(NTFS compressed file is not supported).</p> <p>Note:</p> <p>1.Licenses involved in specifications above are supposed to be obtained by customers themselves, eg:AC3 and DivX.</p> <p>2.MP4 cannot support GMC.</p>					

4. PCB DIMENSIONS

AV IN + YPBPR IN (81_A3)

The size of T.VST59S.81A is 143.5*mm(L)*127.5mm(W)*18mm(H).

Ver.	V1.0
NO.	Description
1	EARPHONE OUT
2	HDMI1 IN
3	HDMI2 IN
4	VGA IN
5	PC AUDIO IN
6	RF IN
7	YPbPr-Y IN
8	YPBPR-Pb IN
9	YPBPR-Pr IN
10	CVBS IN
11	CVBS/YPBPR R IN
12	CVBS/YPBPR L IN
13	USB IN

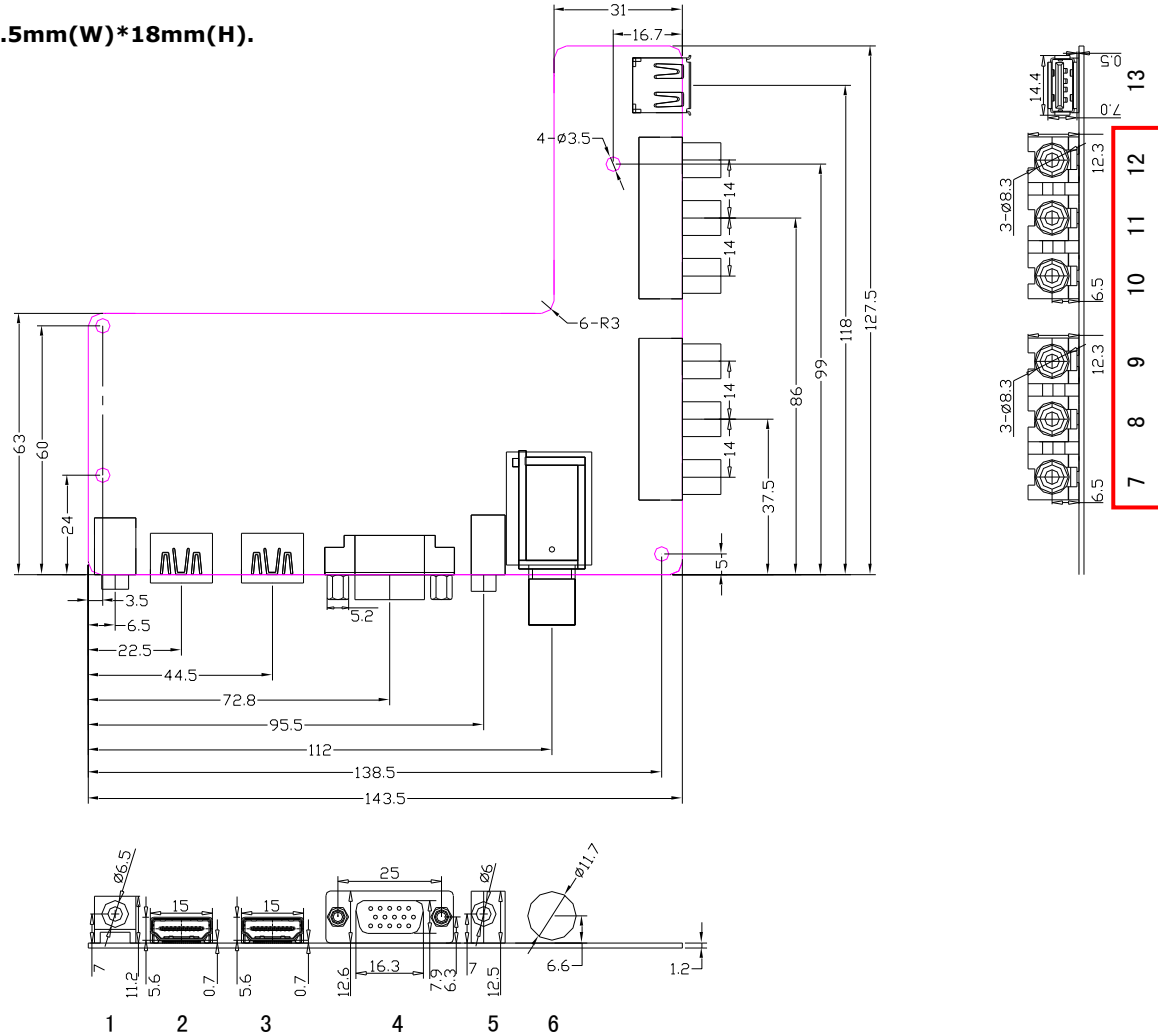

5. SCHEMATICS OF IR BOARD & KEY BOARD

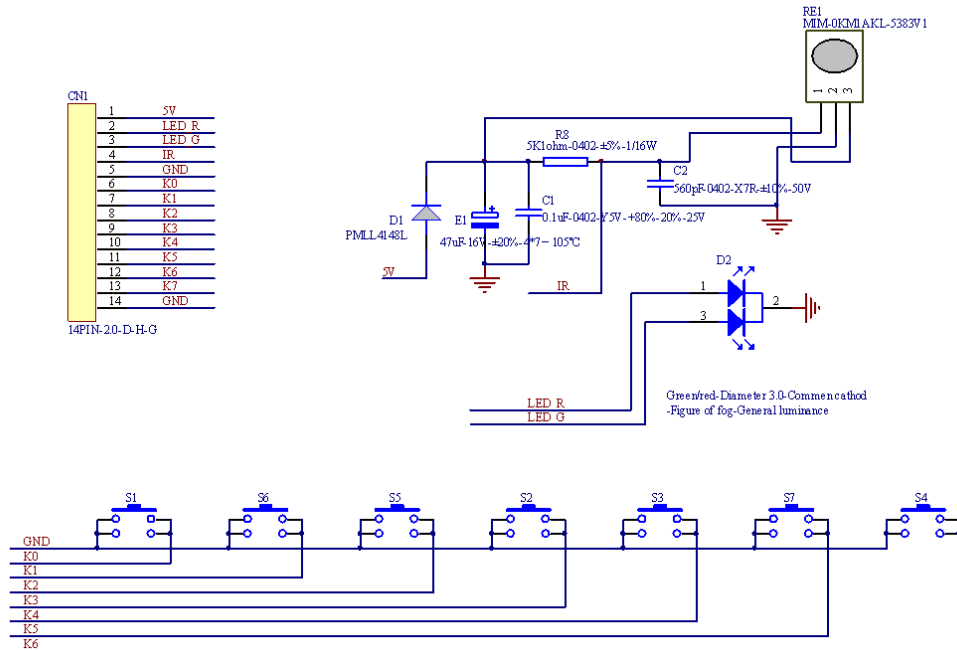

Note: The dividing resistor which is corresponding to the power key must be zero (equivalent to the voltage is zero). Otherwise, the board will not work.

6. INTERFACE DEFINITION

The optional connectors are marked with "*".

◆ CN2(10PIN/2.54): MAIN POWER SUPPLY CONNECTOR

NO.	SYMBOL	DESCRIPTION
1	5VSB	+5V Power Supply when Standby
2	PON	Power On/Off
3	GND	Ground
4	GND	
5	P5V	+5V Power Supply for Panel
6	P5V	
7	5V	+5V DC Power Supply
8	5V	
9	GND	Ground
10	12V	+12V DC Power Supply

◆ *CN11(4PIN/2.0): EXTERNAL USB CONNECTOR

NO.	SYMBOL	DESCRIPTION
1	5V	+5V DC Power Supply for USB
2	DM	USB Data-
3	DP	USB Data+
4	GND	Ground

◆ CN6(6PIN/2.0): INVERTER CONNECTOR

NO.	SYMBOL	DESCRIPTION
1	12V	+12V DC Power Supply
2	12V	
3	BLO	Back-Light ON/OFF Control for Panel
4	ADJ	Brightness Adjustment for Panel
5	GND	Ground
6	GND	

◆ CNA3(4PIN/2.54): SPEAKER CONNECTOR

NO.	SYMBOL	DESCRIPTION
1	LOUT+	Audio Left Channel Output+
2	LOUT-	Audio Left Channel Output-
3	ROUT-	Audio Right Channel Output-
4	ROUT+	Audio Right Channel Output+

◆ CNA1(4PIN/2.54): AMPLIFIER POWER SUPPLY CONNECTOR

NO.	SYMBOL	DESCRIPTION
1	VCC	DC Power Supply (default 24V, 12V or 24V, optional)
2	VCC	
3	GND	Ground
4	GND	

◆ CN8(14PIN/2.0): IR & KEY BOARD CONNECTOR

NO.	SYMBOL	DESCRIPTION
1	5V	+5V DC Power Supply
2	RED	Red Indicator
3	GRN	Green Indicator
4	IR	IR Receiver
5	GND	Ground
6	K0	Key0
7	K1	Key1
8	K2	Key2
9	K3	Key3
10	K4	Key4
11	K5	Key5

T.VST59S.81A (Asia-mini3)-SPECIFICATION

NO.	SYMBOL	DESCRIPTION
12	K6	Key6
13	K7	Key7(Reserved)
14	GND	Ground

◆ *CN1(2×10PIN/2.0): EXTERNAL HDMI CONNECTOR

NO.	SYMBOL	DESCRIPTION
1	HDMI_RX2+	HDMI 2+ Signal
2	HDMI_RX2-	HDMI 2- Signal
3	HDMI_RX1+	HDMI 1+ Signal
4	HDMI_RX1-	HDMI 1- Signal
5	HDMI_RX0+	HDMI 0+ Signal
6	HDMI_RX0-	HDMI 0- Signal
7	HDMI_RXC+	HDMI Clock+ Signal
8	HDMI_RXC-	HDMI Clock- Signal
9	HDMI_SCL	HDMI DDC I ² C SCL
10	HDMI_SDA	HDMI DDC I ² C SDA
11	GND	Ground
12	GND	
13	POW_SINK	HDMI 5V
14	HPD_CON	Hot Plug Detect
15	GND	Ground
16	GND	
17	CEC	CEC Signal
18	+5V	+5V DC Power Supply
19	M_SCL	Main I ² C SCL
20	M_SDA	Main I ² C SDA

◆ CN21(2×20PIN/2.0): LVDS INTERFACE CONNECTOR

NOTE: PIN31~40 are optional. The connector or each PIN can refer to the panel specification.

NO.	SYMBOL	DESCRIPTION
1	VSEL	Power Supply for Panel
2	VSEL	
3	VSEL	
4	GND	Ground
5	GND	
6	GND	
7	RX00-	LVDS ODD 0- Signal
8	RX00+	LVDS ODD 0+ Signal
9	RX01-	LVDS ODD 1- Signal
10	RX01+	LVDS ODD 1+ Signal
11	RX02-	LVDS ODD 2- Signal
12	RX02+	LVDS ODD 2+ Signal

13	GND	Ground
14	GND	
15	RXOC-	LVDS ODD Clock- Signal
16	RXOC+	LVDS ODD Clock+ Signal
17	RXO3-	LVDS ODD 3- Signal
18	RXO3+	LVDS ODD 3+ Signal
19	RXE0-	LVDS EVEN 0- Signal
20	RXE0+	LVDS EVEN 0+ Signal
21	RXE1-	LVDS EVEN 1- Signal
22	RXE1+	LVDS EVEN 1+ Signal
23	RXE2-	LVDS EVEN 2- Signal
24	RXE2+	LVDS EVEN 2+ Signal
25	GND	Ground
26	GND	
27	RXEC-	LVDS EVEN Clock- Signal
28	RXEC+	LVDS EVEN Clock+ Signal
29	RXE3-	LVDS EVEN 3- Signal
30	RXE3+	LVDS EVEN 3+ Signal
*31	GND	Ground
*32	GND	
*33	CON1	Logic Level Control (Default For High Level)
*34	NC	No Connection
*35	VSEL1	Reserved Power or I ² C SCL
*36	VSEL2	Reserved Power or I ² C SDA
*37	RXO4-	LVDS ODD4- Signal
*38	RXO4+	LVDS ODD4+ Signal
*39	RXE4-	LVDS EVEN 4- Signal
*40	RXE4+	LVDS EVEN 4+ Signal

7. CONFIGURATION & GENERAL PRECAUTIONS

- **Relative humidity: ≤ 80%.**
- **Storage temperature: -10~60°C.**
- **Operation temperature: 0~40°C.**
- **Protect the board from static electricity in case of damage to the IC.**
- **Keep the board away from conductor when it is working.**
- **Don't push or pull the connectors when the board is working.**
- **Don't press, distort or disassemble the board.**
- **Clean the board with soft dry cloth when it's dirty.**
- **Don't wire in the board to power supply before panel is correctly connected.**

APPENDIX: ANOTHER TWO STRUCTURE

Mini YPBPR IN+AV OUT+AV IN (81_A1)

Ver.	V1.0
NO.	Description
1	EARPHONE OUT
2	HDMI1 IN
3	HDMI2 IN
4	VGA IN
5	PC AUDIO IN
6	RF IN
7	(Mini)YPbPr IN
8	CVBS OUT
9	CVBS ROUT
10	CVBS LOUT
11	CVBS IN
12	CVBS/YPBPR RIN
13	CVBS/YPBPR LIN
14	USB IN

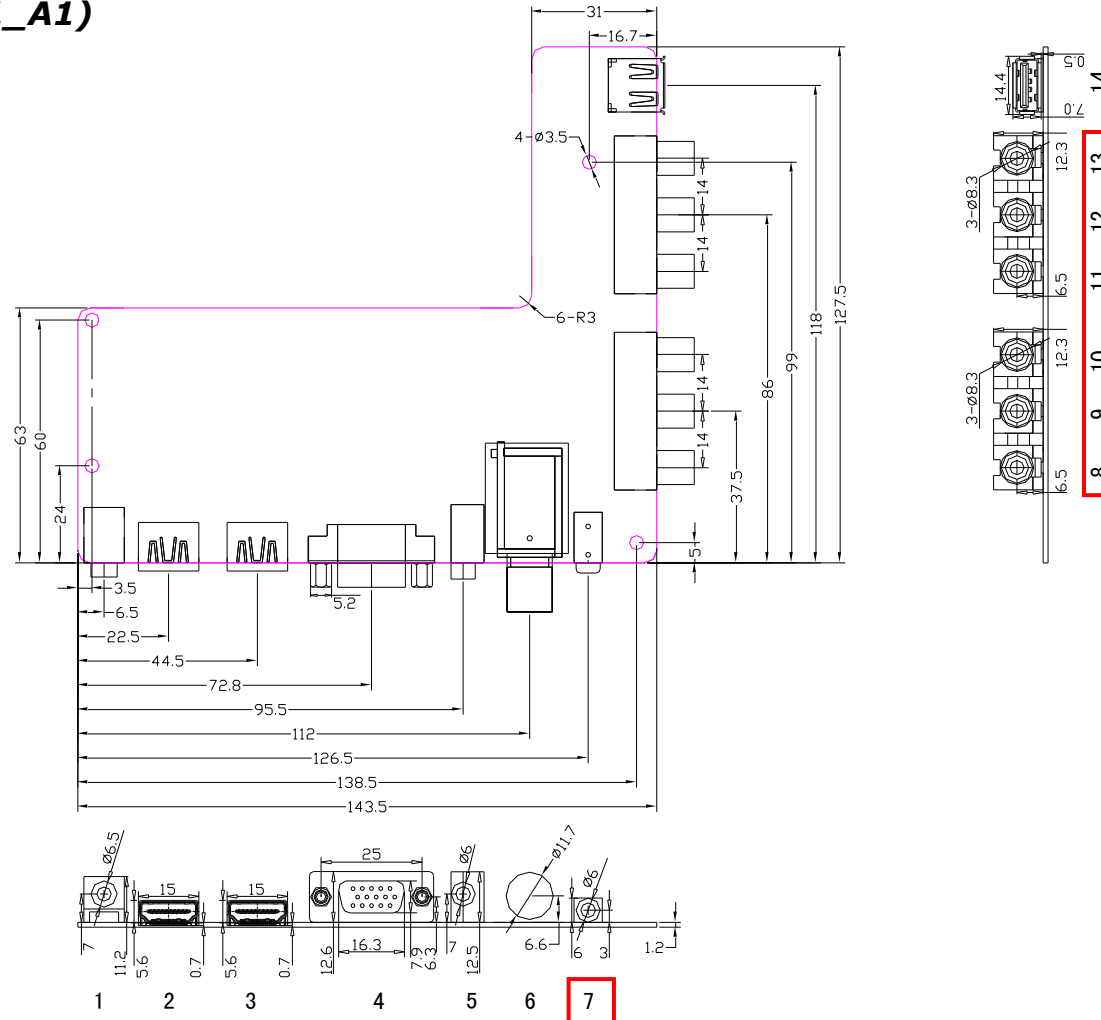

Mini YPBPR IN+2AV IN (81_A2)

Ver.	V1.0
NO.	Description
1	EARPHONE OUT
2	HDMI1 IN
3	HDMI2 IN
4	VGA IN
5	PC AUDIO IN
6	RF IN
7	(Mini)YPbPr IN
8	CVBS1 IN
9	CVBS1/YPBPR RIN
10	CVBS1/YPBPR LIN
11	CVBS2 IN
12	CVBS2 RIN
13	CVBS2 LIN
14	USB IN

