

V1.1

**AV CONTROL BOARD
SPECIFICATION**

MODEL: A.VST29.01B (V29V39)

Part Number: MST-12061667

AUTHOR:

CHECKED BY:

RECHECKED BY:

APPROVED BY:

PUBLISHED DATE:

CONTENT

ITEM	PAGE
1.GENERAL DESCRIPTION	2
2.FUNCTION LAYOUT	2
3.FEATURES	3
4.PCB DIMENSIONS	7
5.SCHEMATICS OF IR & KEY BOARD	9
6.INTERFACE DEFINITION	9
7.CONFIGURATION & GENERAL PRECAUTIONS	13

REVISION HISTORY

VERSION	DATE	BOARD ID	PAGE	DESCRIPTION	AUTHOR
V1.1	2012.06.16	A.VST29.01B 12204	All	Modify description in part1 and picture in part2.	Linda
V1.0	20112.05.09	A.VST29.01A 12156	All	First issued.	Linda

1. GENERAL DESCRIPTION

A.VST29.01B is an analog AV control board, which is suitable for Asia-Pacific and Middle-East market. It can support less than 26 inch LCD/LED panels which resolution is up to 1920×1080.

A.VST29.01B support six kinds of main chip: TSUMV29LU, TSUMV29LE, TSUMV39LU, TSUMV39LE, TSUMV59XU, TSUMV59XE, differences are in the following table.

This specification is only for **A.VST29.01B** with main chip TSUMV29LU/ TSUMV29LE or TSUMV39LU/ TSUMV39LE.

Main Chip	TSUMV29LU	TSUMV29LE	TSUMV39LU	TSUMV39LE	TSUMV59XU	TSUMV59XE
TELETEXT	No	Yes	No	Yes	No	Yes
USB slot function	updating software		updating software, playing MP3 and JPEG		updating software, playing multimedia	

Note: Chipset TSUMV29LU/LE, TSUMV39LU/LE and TSUMV59XU/XE are pin to pin.

There are two configurations: CVBS (RCA) can be compatible with CVBS (BNC).

2. FUNCTION LAYOUT

The picture is for a reference only, the actual item is the standard. The optional connectors and terminals are marked with "*".

ENLARGED VIEW OF CHIPSET

As the picture shows in right, difference the board and chipset by resistance and mark.

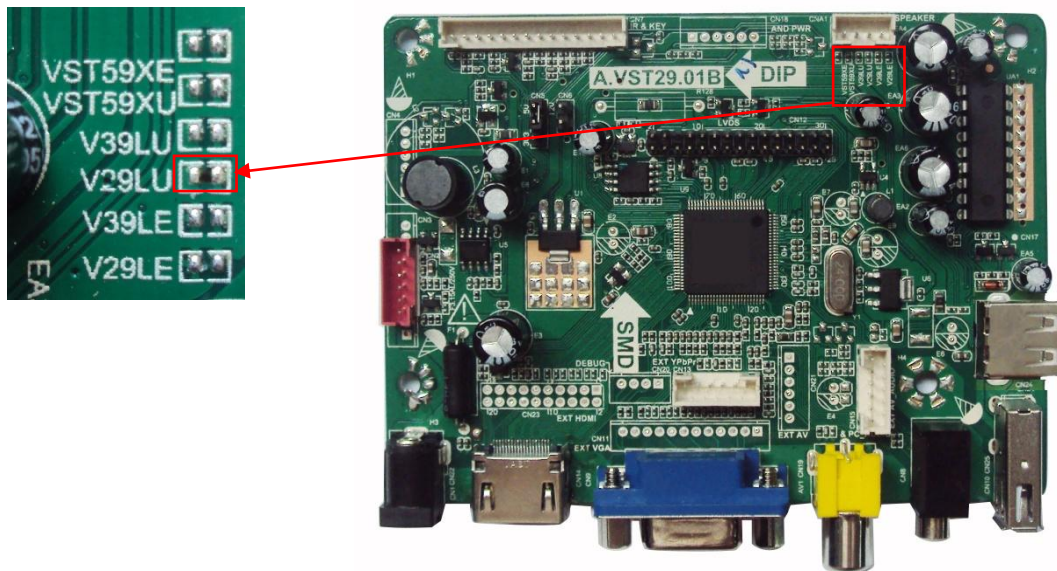

Configuration1: CVBS (RCA)

TOP VIEW OF A.VST29.01B

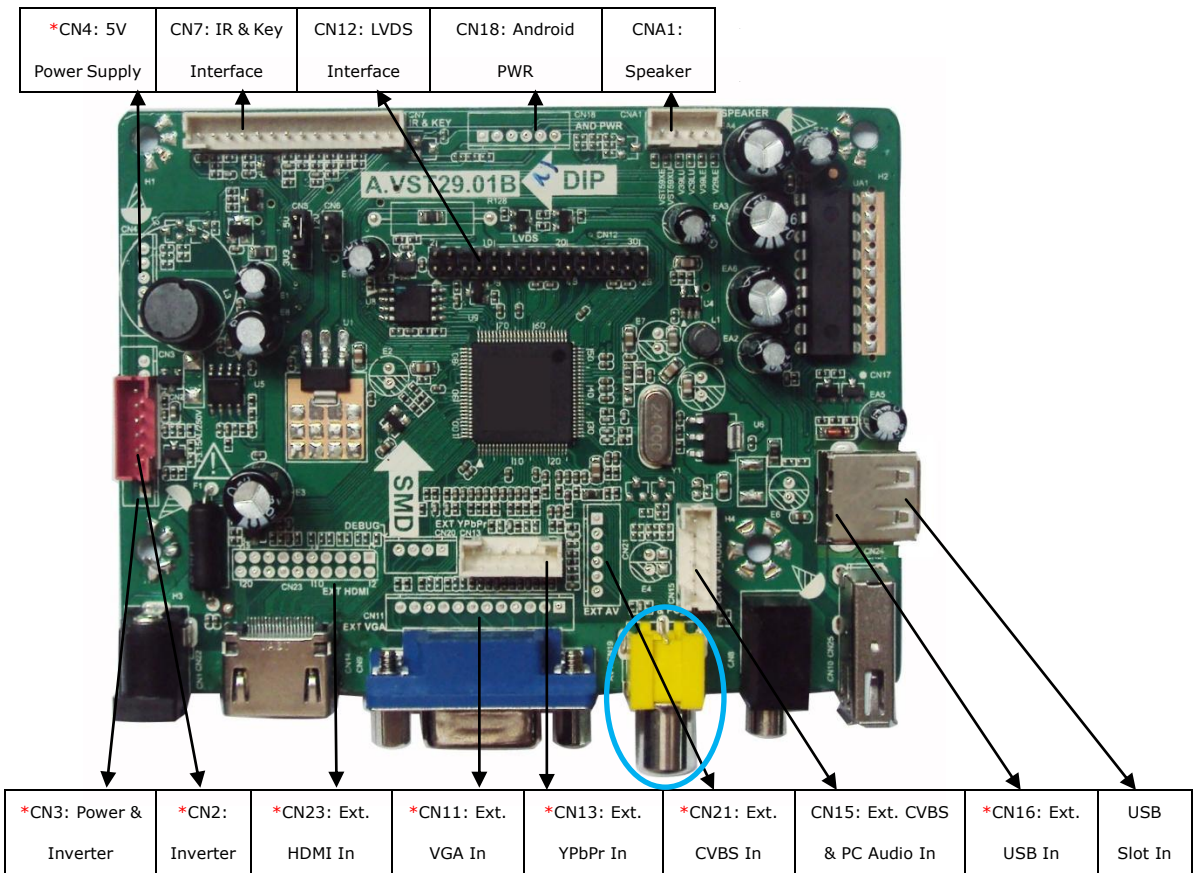

Note:

HDMI terminal and CN23: external HDMI can't coexist with each other.

VGA terminal and CN11: external VGA can't coexist with each other.

AV terminal and CN21: external AV can't coexist with each other.

Only one USB Slot is available, and location of USB is optional. USB terminal and CN16:external USB can't coexist with each other.

FRONT VIEW OF A.VST29.01B

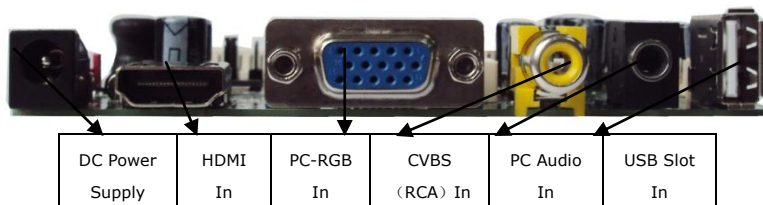

Configuration2: CVBS (BNC)

TOP VIEW OF A.VST29.01B

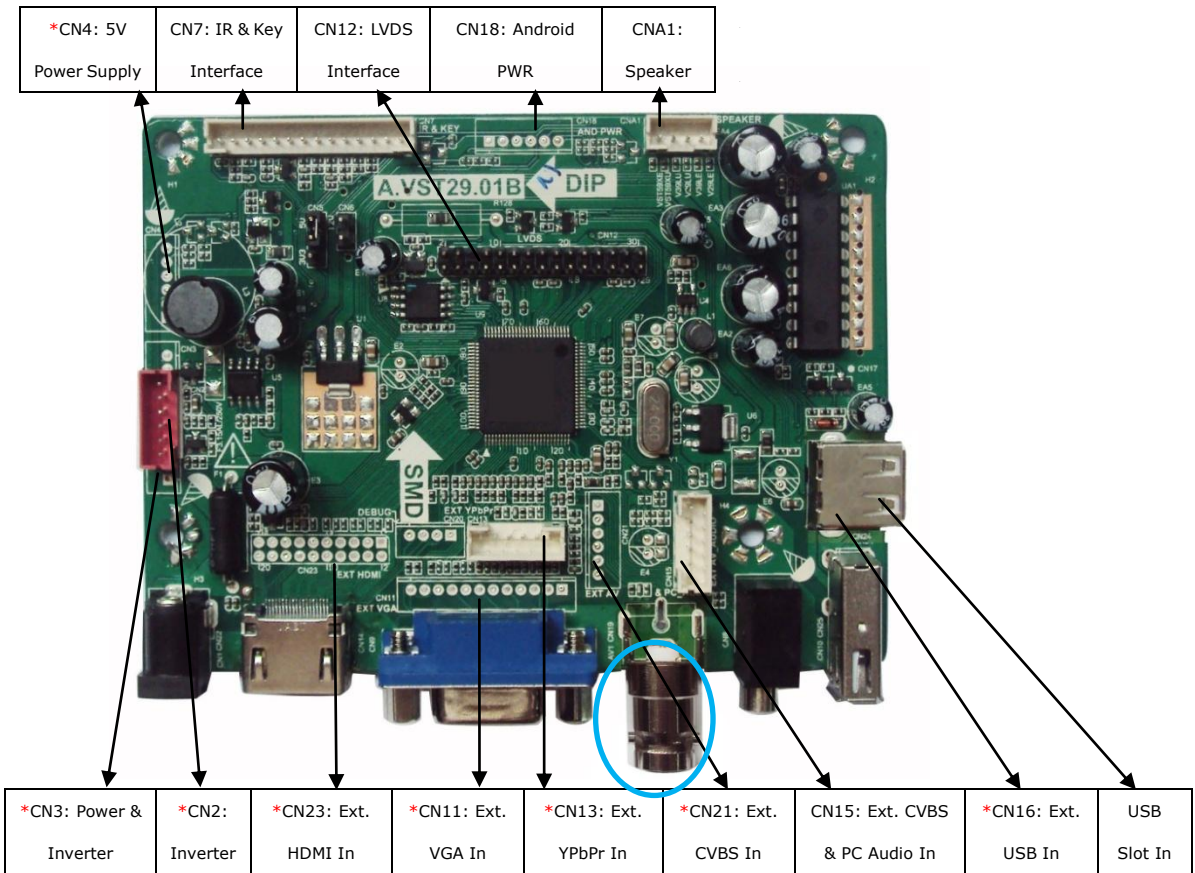

Note:

HDMI terminal and CN23: external HDMI can't coexist with each other.

VGA terminal and CN11: external VGA can't coexist with each other.

AV terminal and CN21: external AV can't coexist with each other.

Only one USB Slot is available, and location of USB is optional. USB terminal and CN16: external USB can't coexist with each other.

FRONT VIEW OF A.VST29.01B

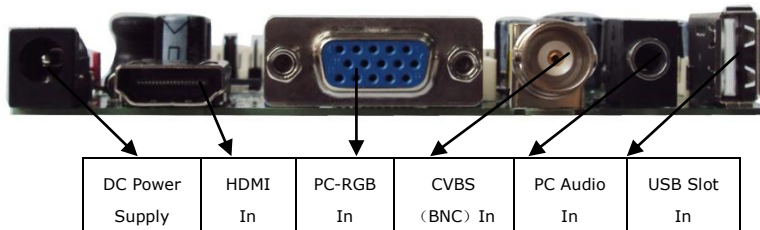

3. FEATURES

CHIPSET	TSUMV29LU/ TSUMV29LE /TSUMV39LU/ TSUMV39LE		
MARKET AREA	Asia-Pacific, Middle-East		
OSD LANGUAGE	English, French, German, Italian, Spanish, Portuguese, Russian(optional)		
PANEL	Panel Type	LED/LCD	
	Interface	Single/Dual LVDS	
	Max Resolution	1920×1080	
VIDEO INPUT	PC-RGB	Format	Up to 1920×1080@60Hz
	CVBS/Ext. CVBS	Video System	PAL/NTSC/SECAM
		Video level	1.0 V _{p-p} ±5%
		TELETEXT (Only for TSUMV29LE,TSUMV39LE)	10Pages
	Ext. YPbPr	480i, 480p, 576i, 576p, 720p, 1080i, 1080p	
	HDMI	480i, 480p, 576i, 576p, 720p, 1080i, 1080p	
AUDIO INPUT	PC Audio	Earphone Input	0.2 ~ 2.0 V _{RMS}
	CVBS/ Ext. CVBS/Ext. YPbPr Audio	L/R Input	0.2 ~ 2.0 V _{RMS}
AUDIO OUTPUT	Frequency Response	100Hz~15KHz @±3dB (1KHz reference signal)	
	Max Output power	2×3W(4Ω) THD+N<10%@1KHz (Power Supply: 12V, Audio Input: 0.5V _{RMS})	
POWER	Requirement	12V DC/12V(built in)/12V,5V(built in)/12V,5V,5VSB(built in)	
	To Panel	3.3V, 5V,12V	
	Management	Standby Power Consumption < 0.3W(Board Only)	
COMB FILTER	2D (TSUMV29LU) /3D(TSUMV39LU)		
DEINTERLACE	2D (TSUMV29LU) /3D(TSUMV39LU)		
KEY FUNCTION	MENU, CH+, CH-, VOL+, VOL-, INPUT, POWER		
EXPANDABLE FUNCTION	--		
Note: Licenses involved in specifications above are supposed to be obtained by customers themselves.			

MULTI MEDIA (MUSIC/PHOTO) PLAYBACK FORMAT

(Only for *TSUMV39LU*)

Multimedia Categories	File Extension	Decoder	Notes
Music	*.mp3	MPEG 1 layer I,II,III MPEG 2 layer III MPEG 2.5 layer III	--
Photo	*.jpg	baseline	Max Image: 4992 x 3328 (16M)
		baseline Thumbnail	Max Image Width: 1920x8(15360)
		Progressive	Max Image: 1240 x 944 (1M)
<p>Note: File system: FAT16/32. Licenses involved in specifications above are supposed to be obtained by customers themselves.</p>			

ELECTRICAL CHARACTERISTICS & REQUIREMENTS

Power Supply Mode	Symbol	Voltage Range	Max Current	Ripple Voltage@25 °C	Startup Time	Rise Time
12V(Ext. Adaptor)	12V	12V±0.6V	2000mA	120mV _{p-p}	--	≤50ms
12V(Built-In)	12V	12V±0.6V	2000mA	120mV _{p-p}	--	≤50ms
12V/5V(Built-In)	12V	12V±0.6V	1300mA	120mV _{p-p}	≤100ms	≤50ms
	5V	5.1V±0.05V	1500mA	50mV _{p-p}	--	≤50ms
12V/5V/5VSB (Built-In)	12V	12V±0.6V	1300mA	120mV _{p-p}	≤100ms	≤50ms
	5V	5.1V±0.05V	1400mA	50mV _{p-p}	≤100ms	≤50ms
	5VSB	5.1V±0.05V	150mA	50mV _{p-p}	--	≤50ms
<p>Note: The current of panel, inverter and extension modules are not included in max current.</p>						

SUBSTITUTABLE PRIMARY MATERIALS

The table is for reference only, the actual item is the standard.

NAME	TYPE	BRAND	BACKUP TYPE	BACKUP BRAND
FLASH	GD25Q16BSIG (16M bits)	GIGA	W25Q16BVSSIG	Winbond
AMPLIFIER	YD1517P	YD	TDA1517P	NXP

4. PCB DIMENSIONS

The size of A.VST29.01B is 109mm(L)*81mm(W)*20mm(H).

Configuration1: CVBS (RCA)

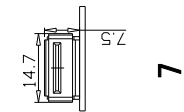
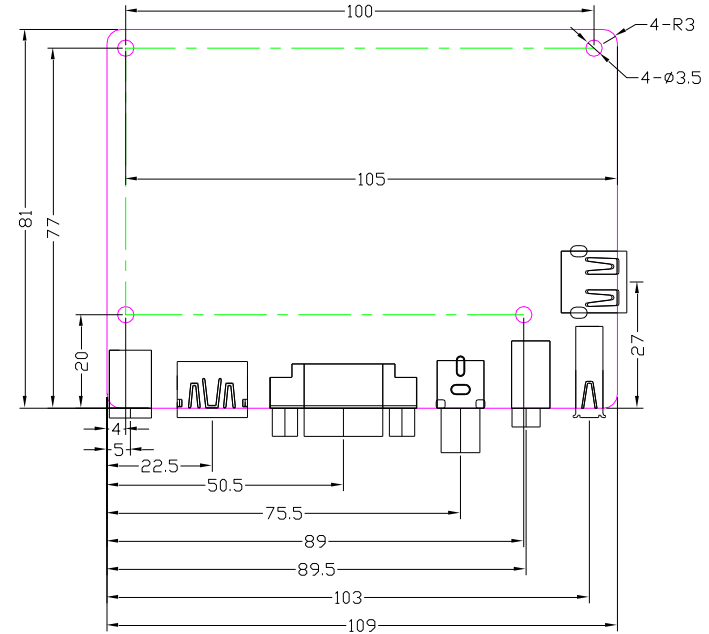

Ver.	V1.0
NO.	Description
1	DC IN
2	HDMI IN
3	VGA IN
4	CVBS IN (RCA)
5	PC AUDIO IN
6	USB1 IN
7	USB2 IN

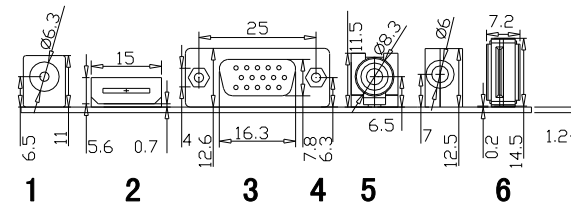

Configuration1: CVBS (BNC)

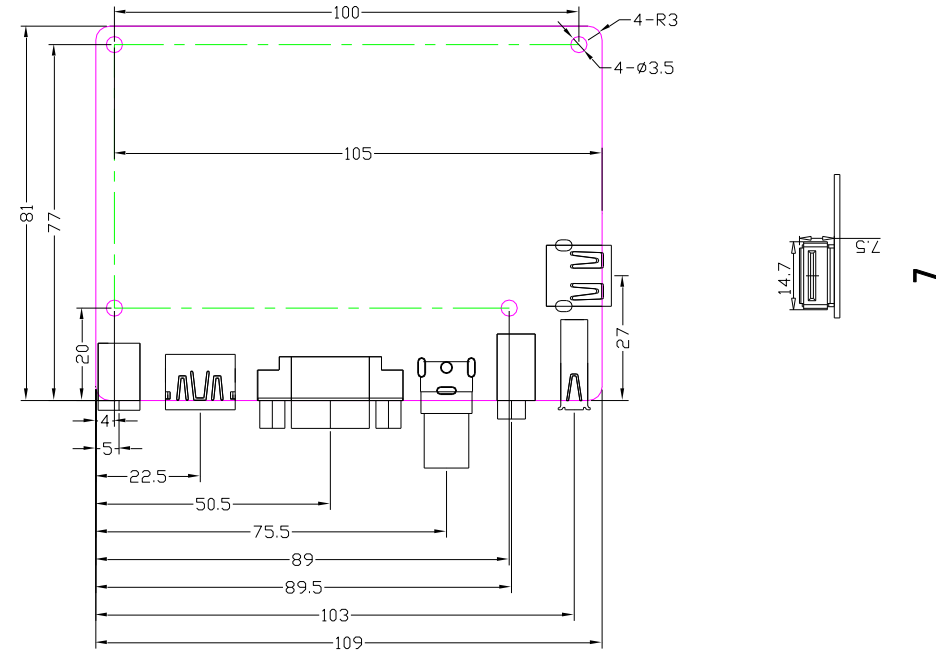

Ver.	V1.0
NO.	Description
1	DC IN
2	HDMI IN
3	VGA IN
4	CVBS1 IN (BNC)
5	PC AUDIO IN
6	USB1 IN
7	USB2 IN

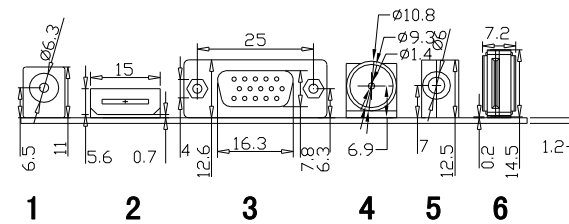

5. SCHEMATICS OF IR BOARD & KEY BOARD

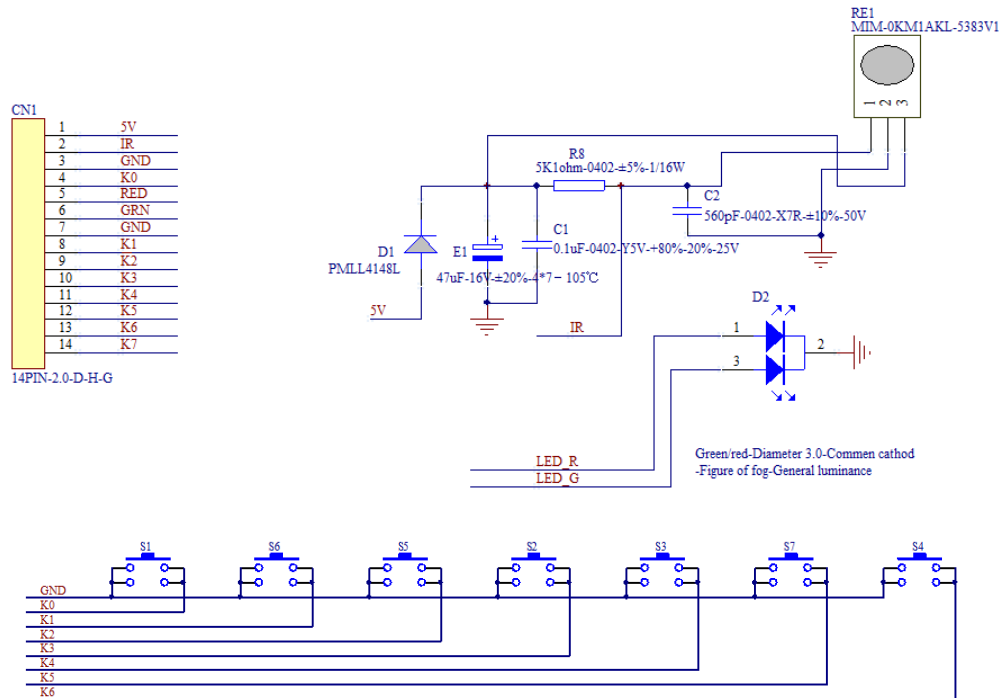

Note: The dividing resistor which is corresponding to the power key must be zero (equivalent to the voltage is zero). Otherwise, the board will not work.

6. INTERFACE DEFINITION

The optional connectors are marked with “*”.

◆ *CN4(6PIN/2.0): 5V POWER SUPPLY CONNECTOR

NO.	SYMBOL	DESCRIPTION
1	5V	+5V DC Power Supply
2	5V	
3	GND	Ground
4	GND	
5	5VSB	+5V DC Power Supply for Standby Mode
6	PWON	Power On/Off

◆ CN7(14PIN/2.0): IR & KEY BOARD CONNECTOR

NO.	SYMBOL	DESCRIPTION
1	5V	+5V DC Power Supply
2	IR	IR Receiver
3	GND	Ground
4	K0	Key0
5	L_R	Red Indicator
6	L_G	Green Indicator

A.VST29.01B (V29V39)-SPECIFICATION

NO.	SYMBOL	DESCRIPTION
7	GND	Ground
8	K1	Key1
9	K2	Key2
10	K3	Key3
11	K4	Key4
12	K5	Key5
13	K6	Key6
14	K7	Key7(Reserved)

◆ CN12(2×15PIN/2.0): LVDS INTERFACECONNECTOR

NO.	SYMBOL	DESCRIPTION
1	VSEL	Power Supply for Panel
2	VSEL	
3	VSEL	
4	GND	Ground
5	GND	
6	GND	
7	TX00-	LVDS ODD 0- Signal
8	TX00+	LVDS ODD 0+ Signal
9	TX01-	LVDS ODD 1- Signal
10	TX01+	LVDS ODD 1+ Signal
11	TX02-	LVDS ODD 2- Signal
12	TX02+	LVDS ODD 2+ Signal
13	GND	Ground
14	GND	
15	TXOC-	LVDS ODD Clock- Signal
16	TXOC+	LVDS ODD Clock+ Signal
17	TX03-	LVDS ODD 3- Signal
18	TX03+	LVDS ODD 3+ Signal
19	TXE0-	LVDS EVEN 0- Signal
20	TXE0+	LVDS EVEN 0+ Signal
21	TXE1-	LVDS EVEN 1- Signal
22	TXE1+	LVDS EVEN 1+ Signal
23	TXE2-	LVDS EVEN 2- Signal
24	TXE2+	LVDS EVEN 2+ Signal
25	GND	Ground
26	GND	
27	TXEC-	LVDS EVEN Clock- Signal
28	TXEC+	LVDS EVEN Clock+ Signal
29	TXE3-	LVDS EVEN 3- Signal
30	TXE3+	LVDS EVEN 3+ Signal

◆ **CN18(6PIN/2.0): Android PWR CONNECTOR**

NO.	SYMBOL	DESCRIPTION
1	12V	+12V DC Power Supply
2	12V	
3	GND	Ground
4	GND	
5	STB/AND	AND Standby Control
6	IR/AND	IR Data Transfer to AND

◆ **CNA1(4PIN/2.0): SPEAKER CONNECTOR**

NO.	SYMBOL	DESCRIPTION
1	LSPK	Audio Left Channel Output
2	GND	Ground
3	GND	
4	RSPK	Audio Right Channel Output

◆ ***CN3(10PIN/2.0):MAIN POWER SUPPLY & INVERTER CONNECTOR**

NO.	SYMBOL	DESCRIPTION
1	12V	+12V DC Power Supply
2	12V	
3	12V	
4	12V	
5	BLO	Back-Light ON/OFF Control for Panel
6	ADJ	Brightness Adjustment for Panel
7	GND	Ground
8	GND	
9	GND	
10	GND	

◆ ***CN2(6PIN/2.0): INVERTER CONNECTOR**

NO.	SYMBOL	DESCRIPTION
1	12V	+12V DC Power Supply
2	12V	
3	BLO	Back-Light ON/OFF Control for Panel
4	ADJ	Brightness Adjustment for Panel
5	GND	Ground
6	GND	

◆ ***CN23(2x10PIN/2.0): EXTERNAL HDMI CONNECTOR**

NO.	SYMBOL	DESCRIPTION
1	HDMI_RX2+	HDMI 2+ Signal
2	HDMI_RX2-	HDMI 2- Signal

A.VST29.01B (V29V39)-SPECIFICATION

NO.	SYMBOL	DESCRIPTION
3	HDMI_RX1+	HDMI 1+ Signal
4	HDMI_RX1-	HDMI 1- Signal
5	HDMI_RX0+	HDMI 0+ Signal
6	HDMI_RX0-	HDMI 0- Signal
7	HDMI_RXC+	HDMI Clock+ Signal
8	HDMI_RXC-	HDMI Clock- Signal
9	HDMI_SCL	HDMI DDC I ² C SCL
10	HDMI_SDA	HDMI DDC I ² C SDA
11	GND	Ground
12	GND	
13	POW_SINK	HDMI 5V
14	HPD_CON	Hot Plug Detect
15	GND	Ground
16	GND	
17	NC	No Connection
18	NC	
19	NC	
20	NC	

◆ ***CN11(12PIN/2.0): EXTERNAL VGA CONNECTOR**

NO.	SYMBOL	DESCRIPTION
1	GND	Ground
2	VS	VS
3	HS	HS
4	GND	Ground
5	R	Red
6	GND	Ground
7	G	Green
8	GND	Ground
9	B	Blue
10	GND	Ground
11	SDA	Serial data
12	SCL	Serial clock

◆ ***CN13(6PIN/2.0): EXTERNAL YPBPR INPUT CONNECTOR**

NO.	SYMBOL	DESCRIPTION
1	Y	External Component-Y Input
2	GND	Ground
3	PB	External Component-Pb Input
4	GND	Ground
5	PR	External Component-Pr Input
6	GND	Ground

◆ ***CN21(6PIN/2.0): EXTERNAL CVBS INPUT CONNECTOR**

NO.	SYMBOL	DESCRIPTION
1	CVBS1	CVBS1 Input
2	GND	Ground
3	CVBS2	CVBS2 Input
4	GND	Ground
5	CVBS3	CVBS3 Input
6	GND	Ground

◆ **CN15(6PIN/2.0): EXTERNAL CVBS & PC AUDIO INPUT CONNECTOR**

NO.	SYMBOL	DESCRIPTION
1	PCL	PC Audio Left Channel Input
2	GND	Ground
3	PCR	PC Audio Right Channel Input
4	AVL	CVBS Audio Left Channel Input
5	GND	Ground
6	AVR	CVBS Audio Right Channel Input

◆ ***CN16(4PIN/2.0): EXTERNAL USB CONNECTOR**

NO.	SYMBOL	DESCRIPTION
1	GND	Ground
2	DP	USB Data+
3	DM	USB Data-
4	5V	+5V DC Power Supply for USB

7. CONFIGURATION & GENERAL PRECAUTIONS

- **Relative humidity: ≤ 80%.**
- **Storage temperature: -10~60°C.**
- **Operation temperature: 0~40°C.**
- **Protect the board from static electricity in case of damage to the IC.**
- **Keep the board away from conductor when it is working.**
- **Don't push or pull the connectors when the board is working.**
- **Don't press , distort or disassemble the board.**
- **Clean the board with soft dry cloth when it's dirty.**
- **Don't wire in the board to power supply before panel is correctly connected.**